



Rigid Face Aluminium Sign Systems

Durable, sleek and long-lasting displays delivering clear, professional messaging for internal and external use.

NovaSlim

At just 90mm deep, the system is ideal for smaller acrylic faced signs. Available screw free and double sided, it is perfectly suited for internal and external signage.

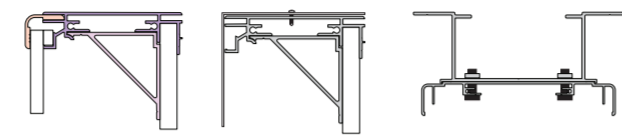
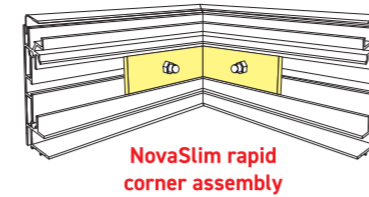

Find out more
For more information, click
www.nova-aluminium.com/novaslim

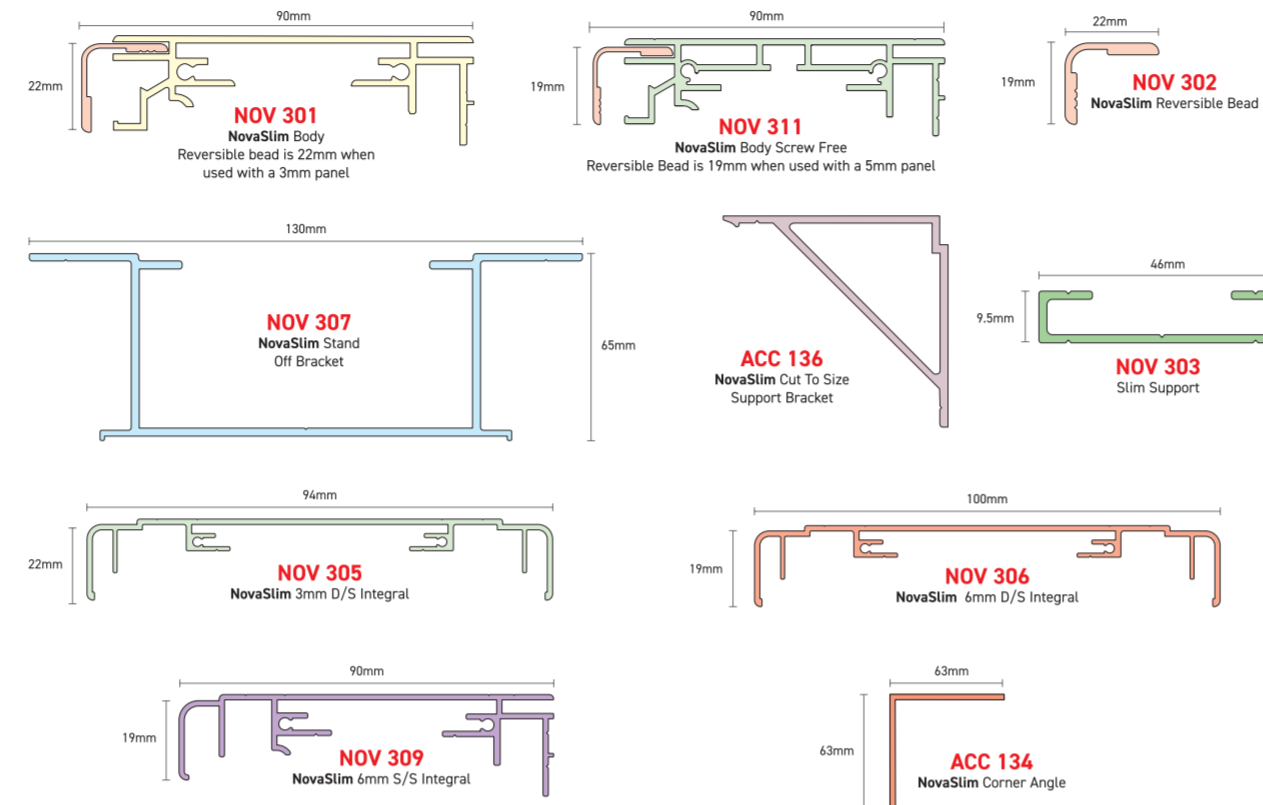

NovaCase, NovaWide and NovaLarge

Robust systems for acrylic signage in both single and double sided formats. NovaLarge is specifically designed to fit between gantry posts to form totem signs.

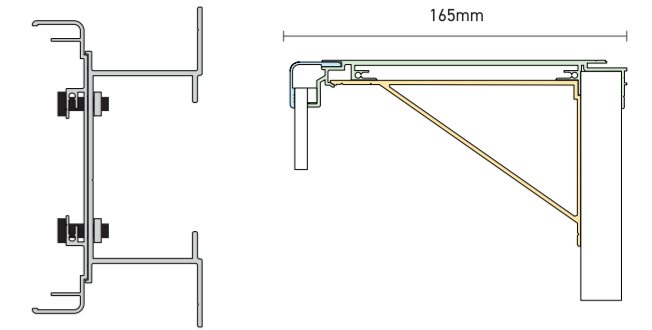

Find out more
For more information, click
www.nova-aluminium.com/nova-case

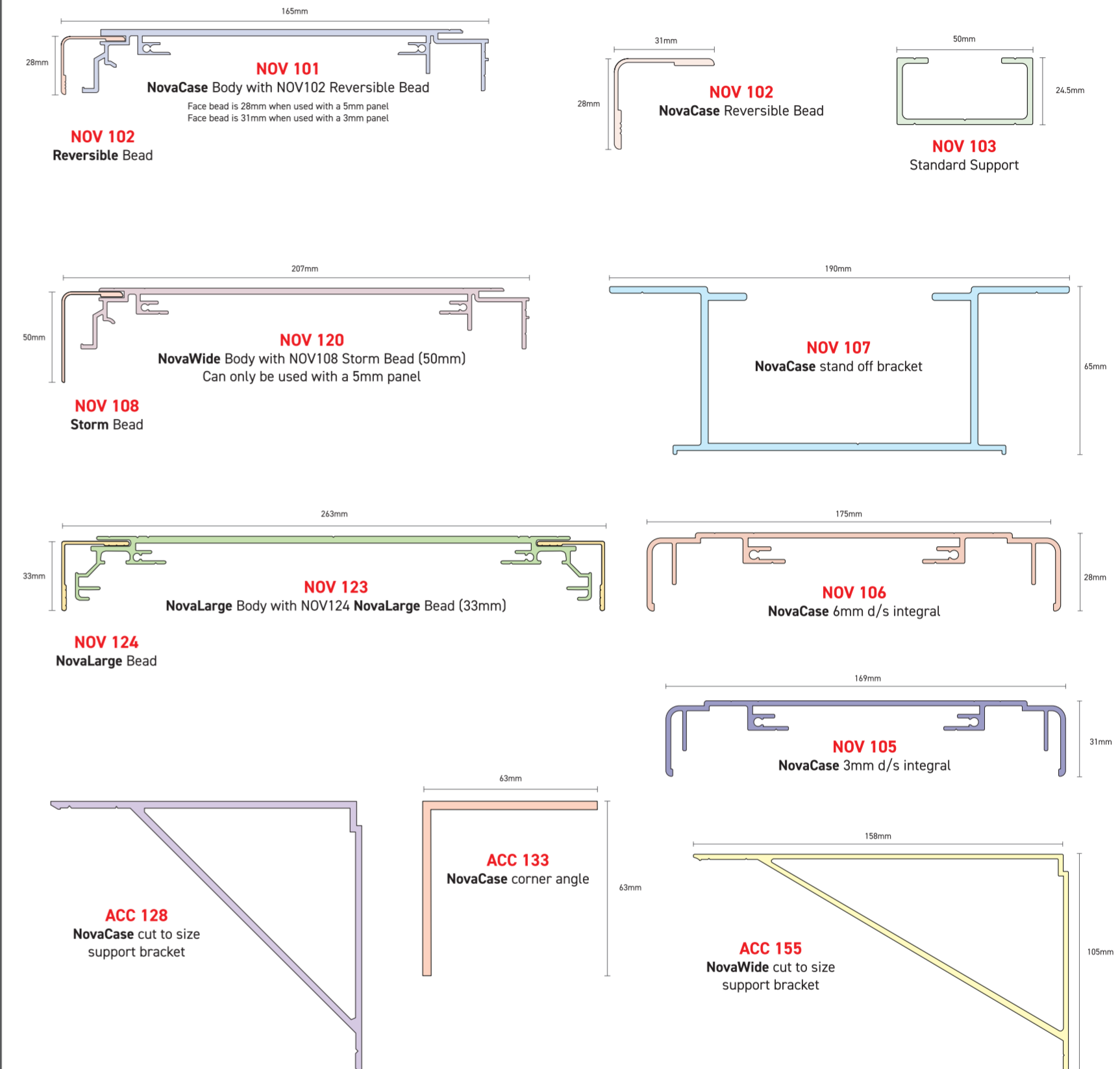

NovaTrim

An extremely simple and cost effective one piece framing system for rigid panels 2-6mm thick.

Find out more
For more information, click
www.nova-aluminium.com/nova-trim

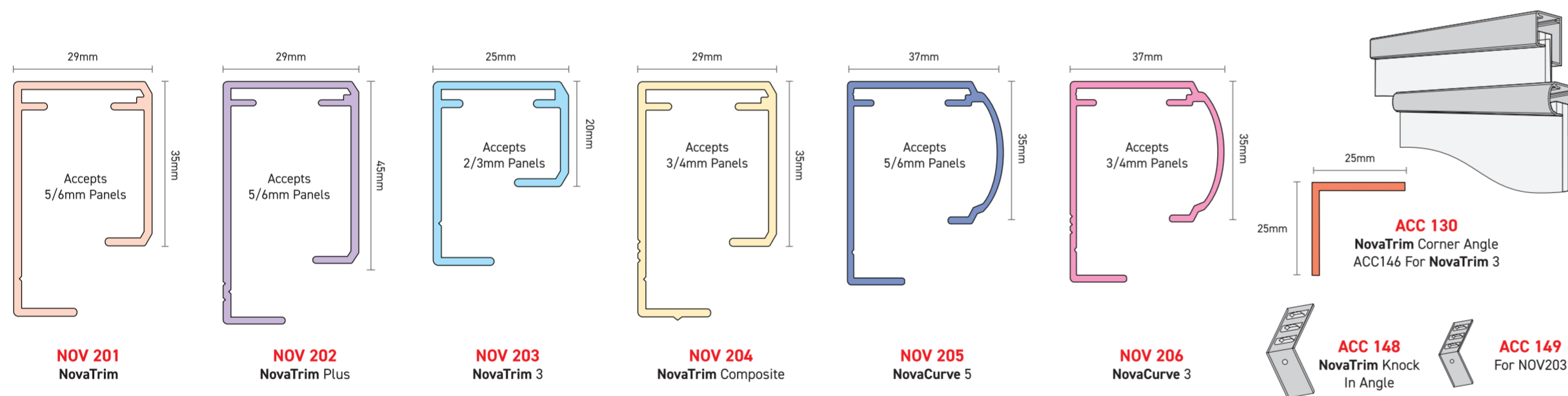

NovaTube and NovaHood

Quality overhead lighting systems with a range of brackets to suit every application.

Find out more
For more information, click
www.nova-aluminium.com/novatube
www.nova-aluminium.com/novahood

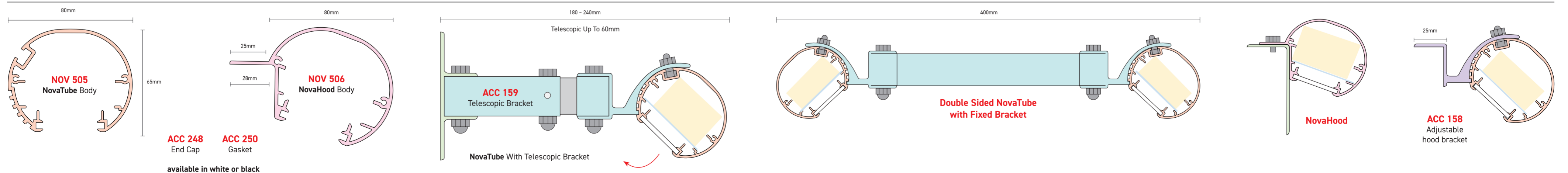

Diagrams not to scale

Call us: 0117 955 6463 Email us: team@nova-aluminium.com Visit us: www.nova-aluminium.com

