

# Wayfinding Aluminium Sign Systems

Reducing confusion, saving time and creating a smoother, less stressful experience from arrival to destination.

## Pole and Plank

Provides a slim and modern wayfinding system with a range of off the shelf and bespoke options.

Find out more  
For more information, click:  
[www.nova-aluminium.com/pole-plank](http://www.nova-aluminium.com/pole-plank)

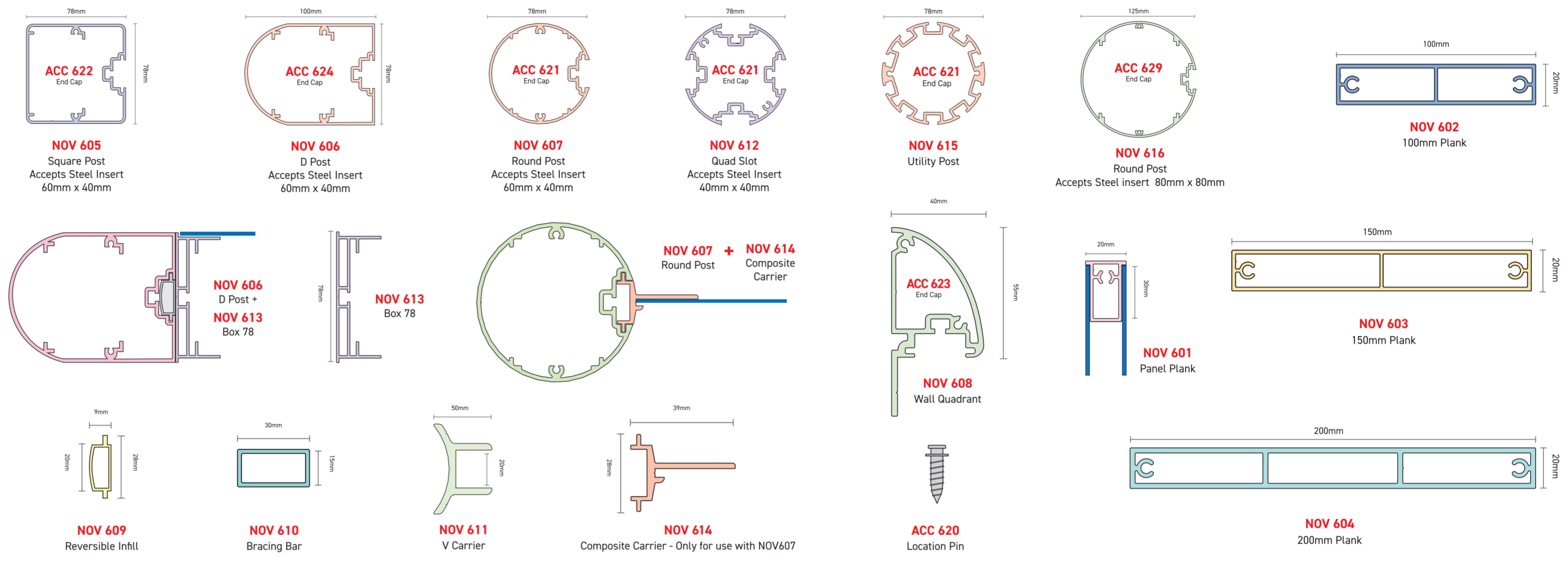
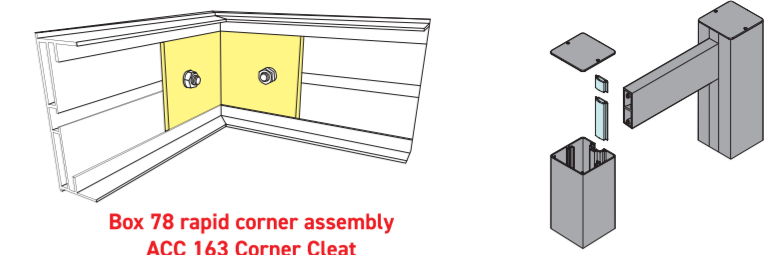

## NovaGuide

A unique screw free framing system for internal use that accepts 5mm rigid panels - ideal for use in retail as directional signage.

Find out more  
For more information, click:  
[www.nova-aluminium.com/novaguide](http://www.nova-aluminium.com/novaguide)

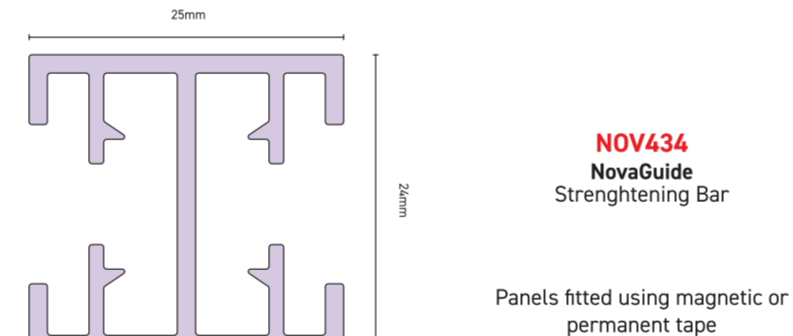
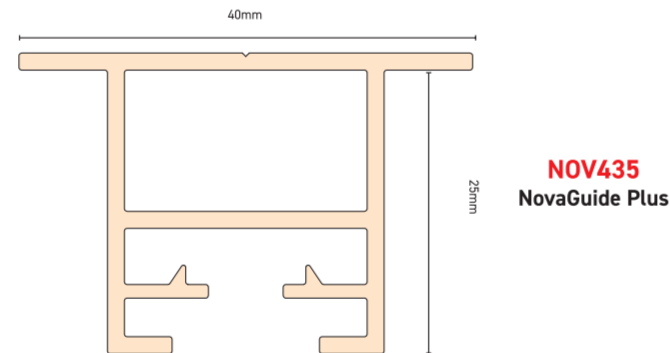
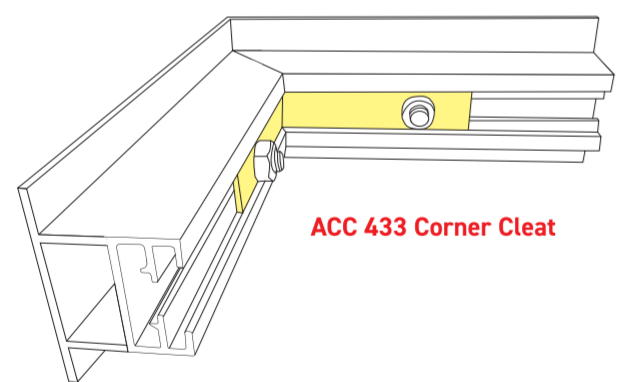

**Fixing Channel** Our seamless riveting system is a robust, reliable mechanical signage system that is stronger and more durable than simple tapes or adhesives.

Find out more  
For more information, click:  
[www.nova-aluminium.com/post-and-rail](http://www.nova-aluminium.com/post-and-rail)

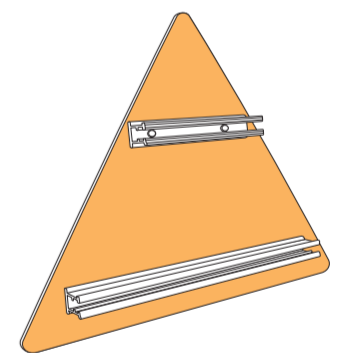
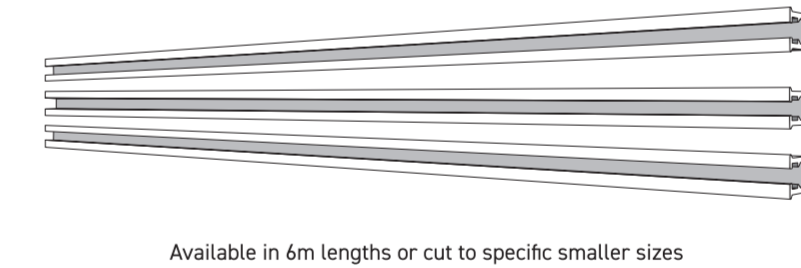
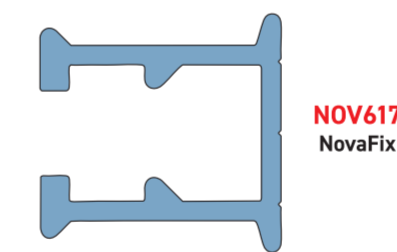

## NovaTube and NovaHood

Quality overhead lighting systems with a range of brackets to suit every application.

Find out more  
For more information, click:  
[www.nova-aluminium.com/novatube](http://www.nova-aluminium.com/novatube)  
[www.nova-aluminium.com/novahood](http://www.nova-aluminium.com/novahood)

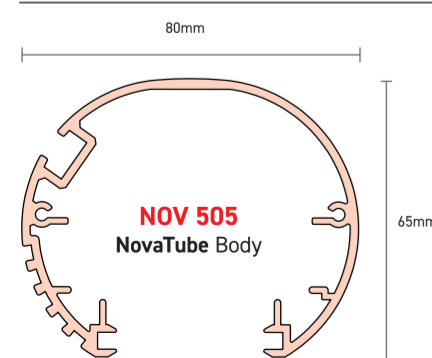

ACC 248  
End Cap  
ACC 250  
Gasket  
available in white or black

